

How to create a single-sided large print guide:

Step 4. Staple the pages together on the two staple icons

Step 3. Place the last (bottom) page upside down, so that it appears on the back of the guide

Step 2. Place pages on top of each other, putting the top page on top, continuing along with page 2, page 3, etc.

Step 1. Cut pages out along dotted lines



} top page

LEGEND

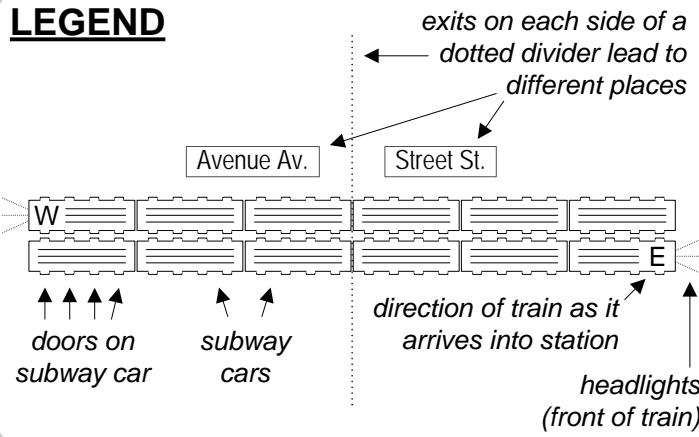

} page 2

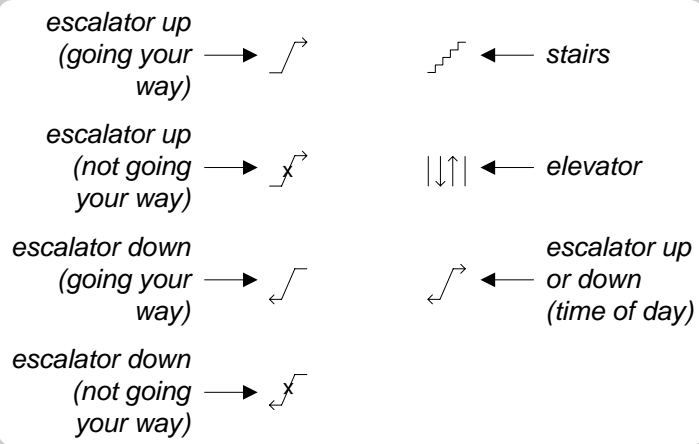

} page 3

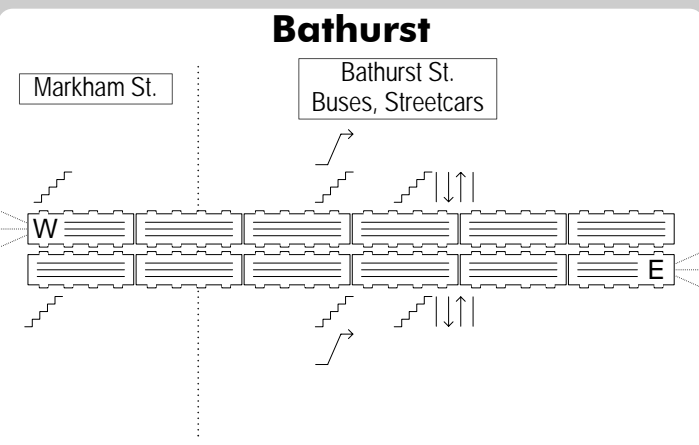

} page 4

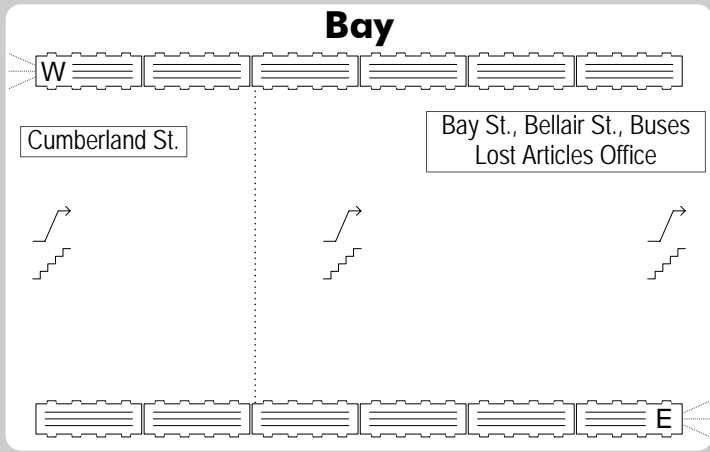

} page 5

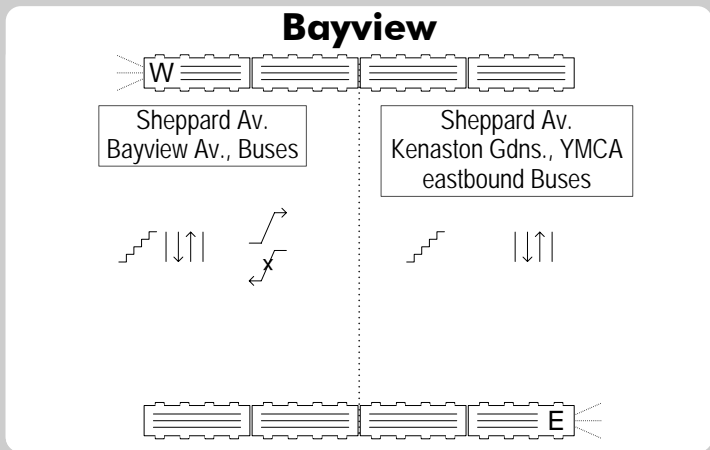

} page 6

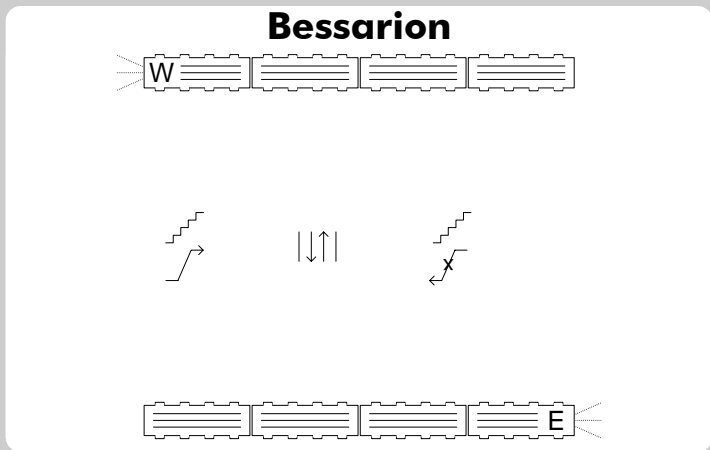

} page 7

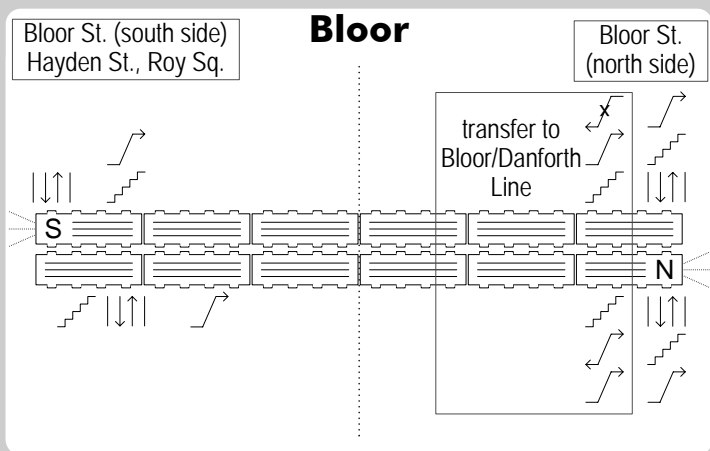

} page 8

Broadview

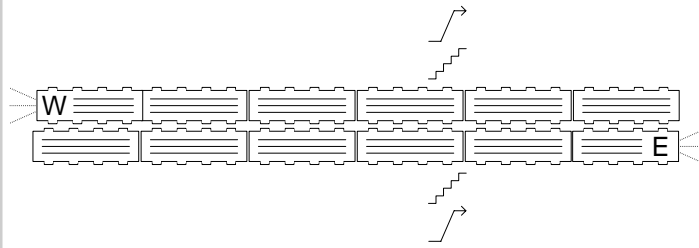

} page 9

Castle Frank

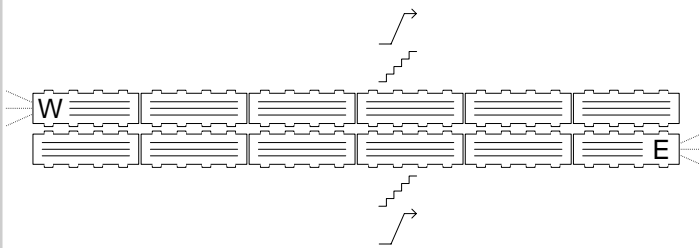

} page 10

Chester

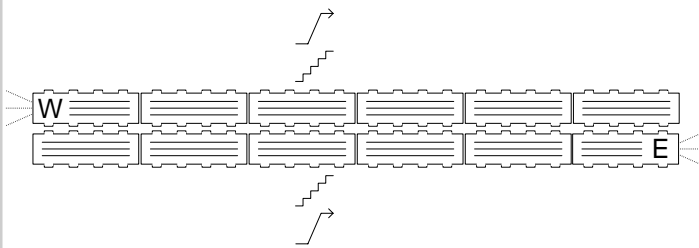

} page 11

Christie

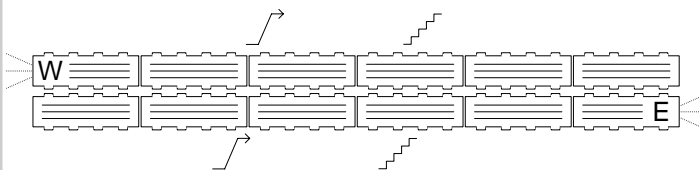

} page 12

College

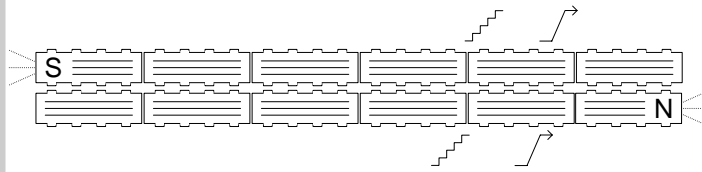

} page 13

Coxwell

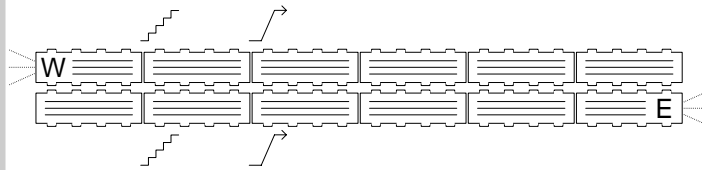

} page 14

Davisville

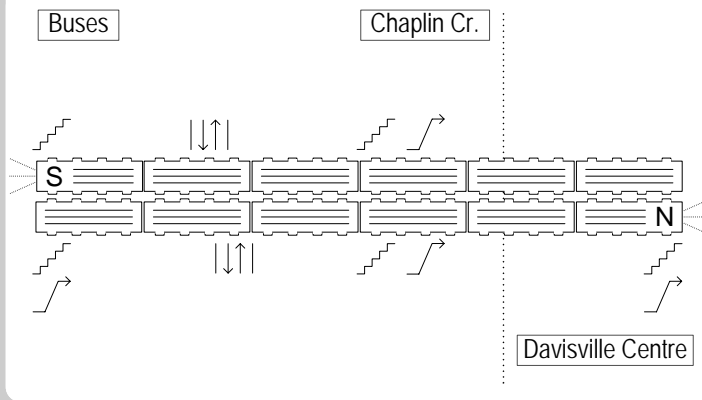

} page 15

Don Mills

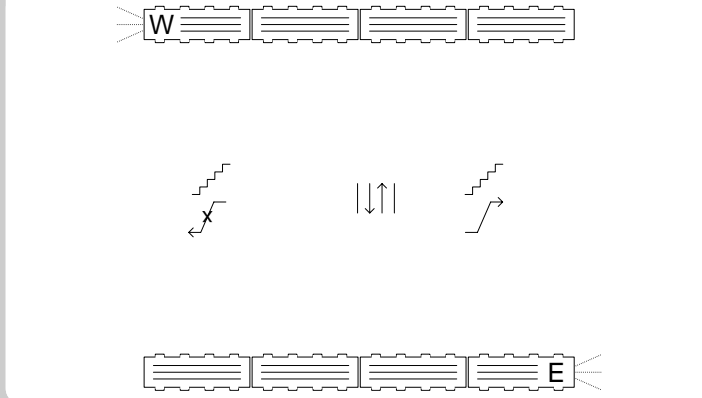

} page 16

Donlands

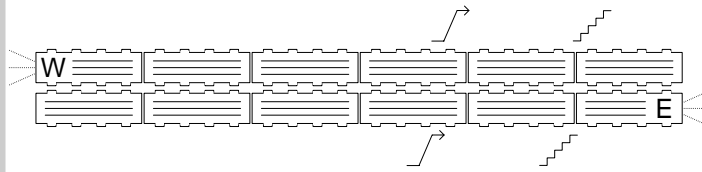

} page 17

Downsview

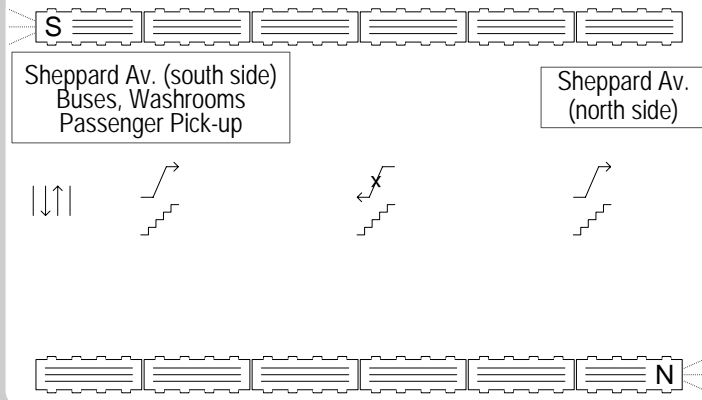

} page 18

Dufferin

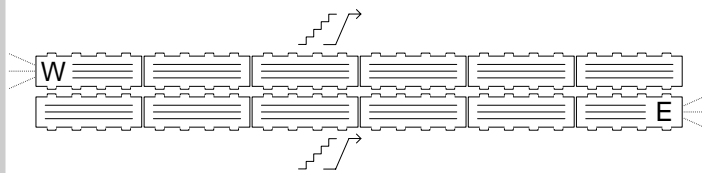

} page 19

Dundas

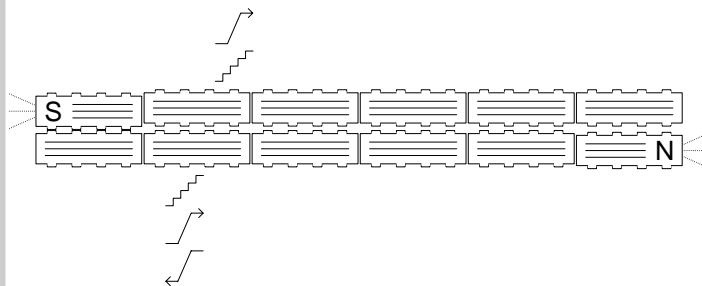

} page 20

Dundas West

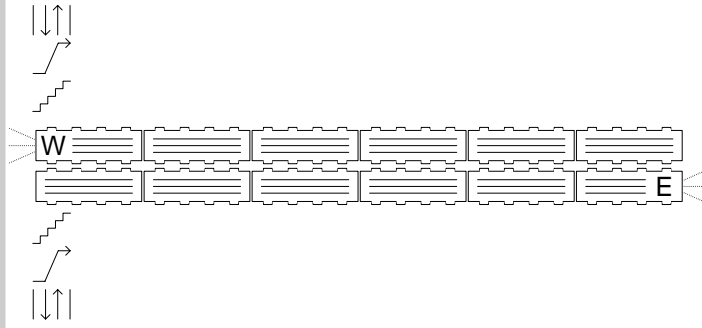

} page 21

Dupont

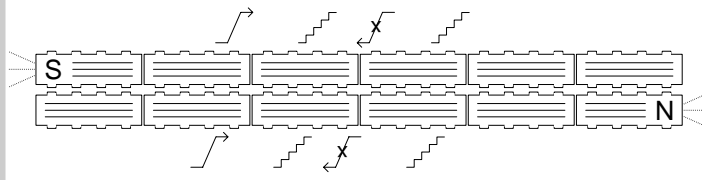

} page 22

Eglinton

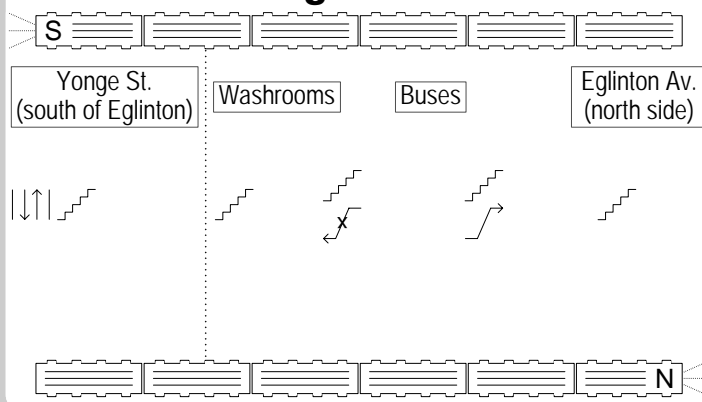

} page 23

Eglinton West

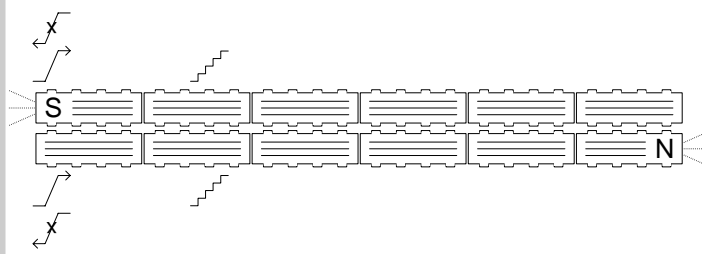

} page 24

Ellesmere

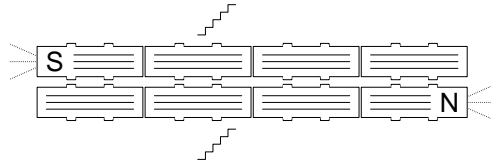

} page 25

Finch

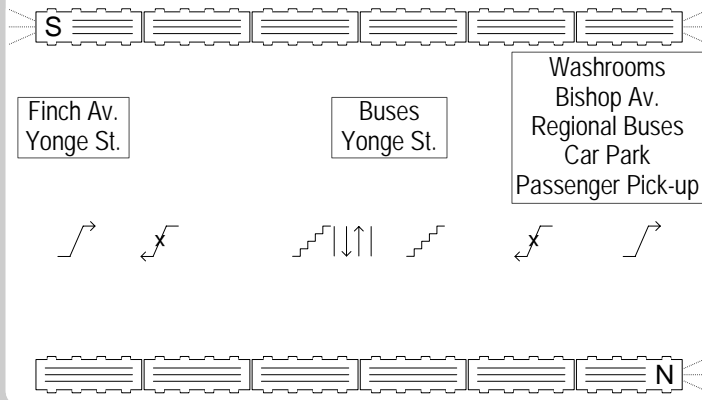

} page 26

Glencairn

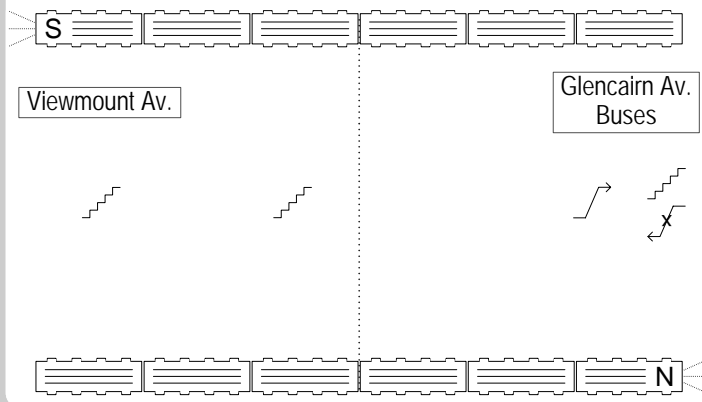

} page 27

Greenwood

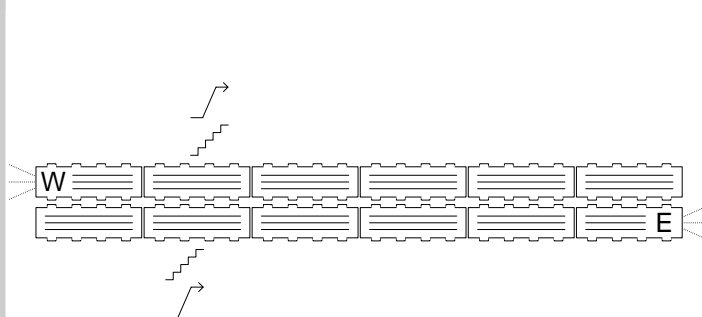

} page 28

High Park

Parkview Gdns.

High Park Av.,
Quebec Av., Buses

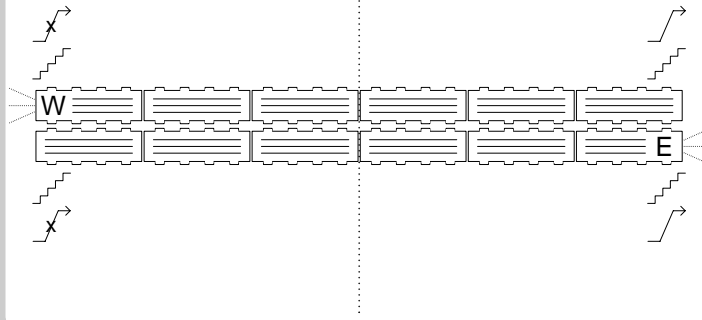

} page 29

Islington

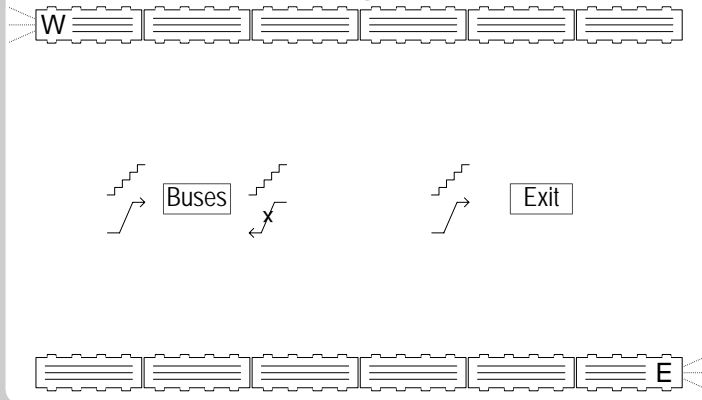

} page 30

Jane

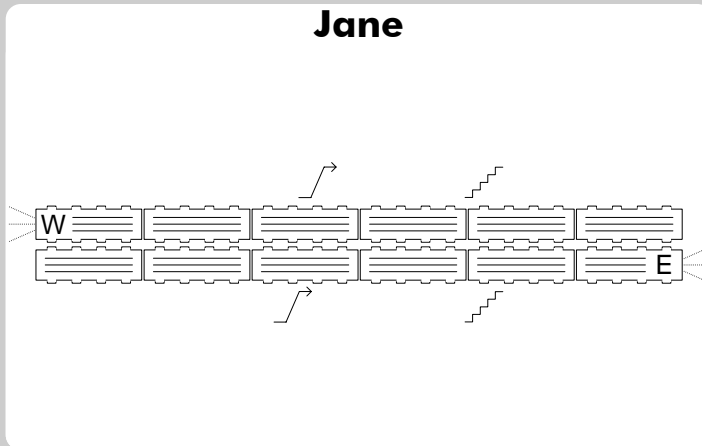

} page 31

Keele

Keele St.
Buses

Indian Groove
Car Park

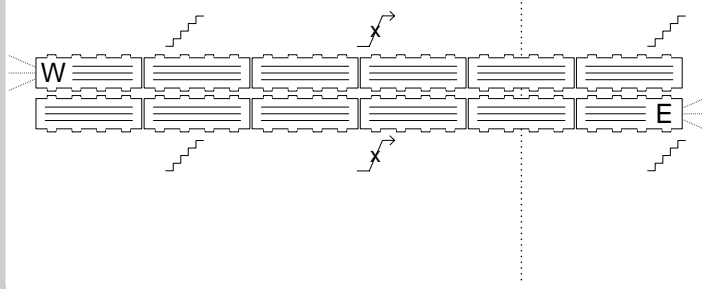

} page 32

Kennedy (Subway)



Eglinton Av., Buses, RT
 Passenger Pick-up
 Taxis, Parking Lot

Buses, RT, Washrooms
 Mid-Scarborough C.C.

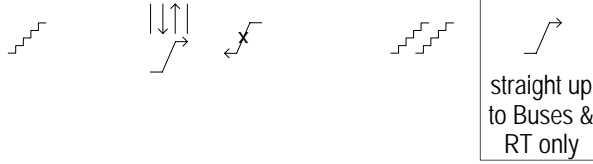

} page 33

Kennedy (RT)

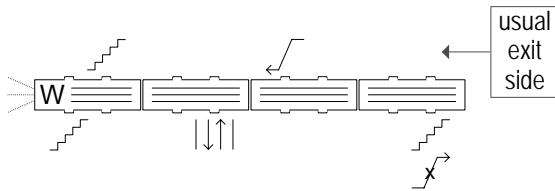

} page 34

King

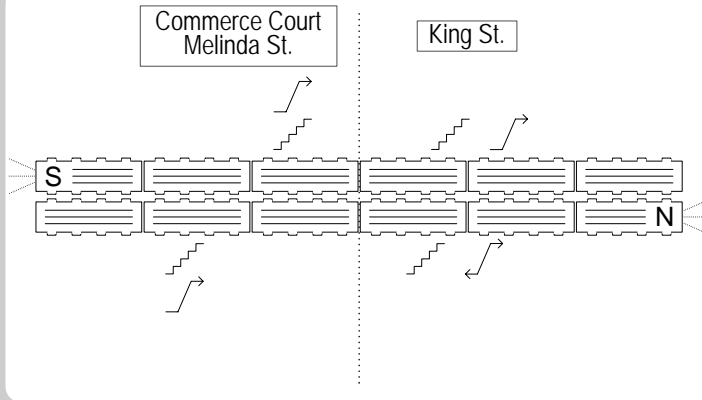

} page 35

Kipling

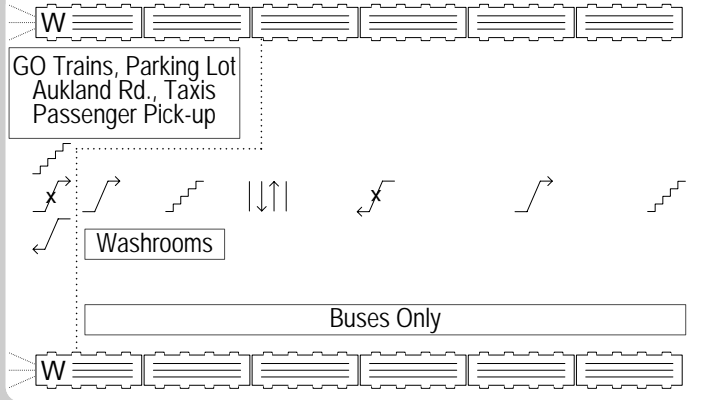

} page 36

Lansdowne

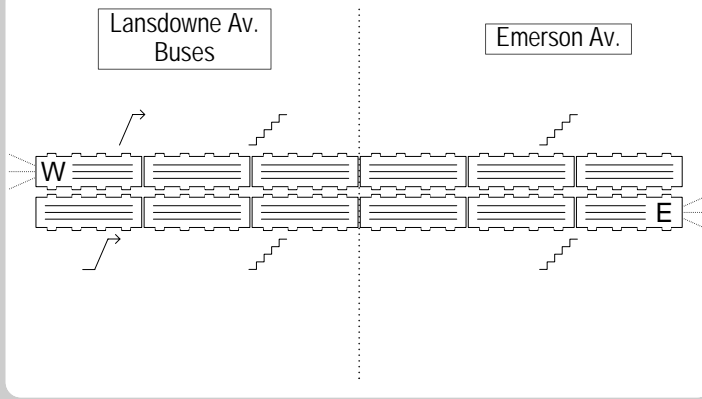

} page 37

Lawrence

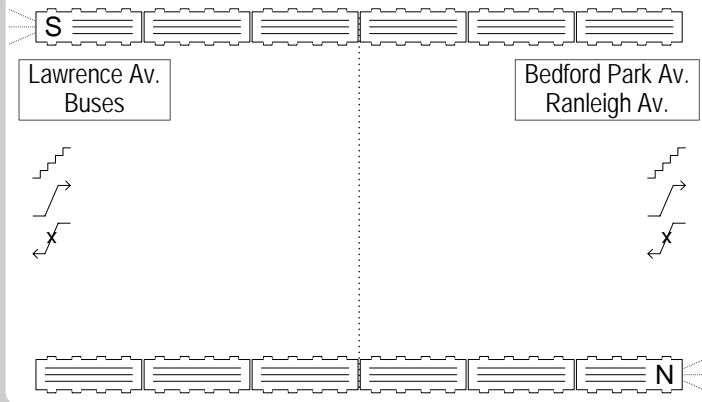

} page 38

Lawrence East

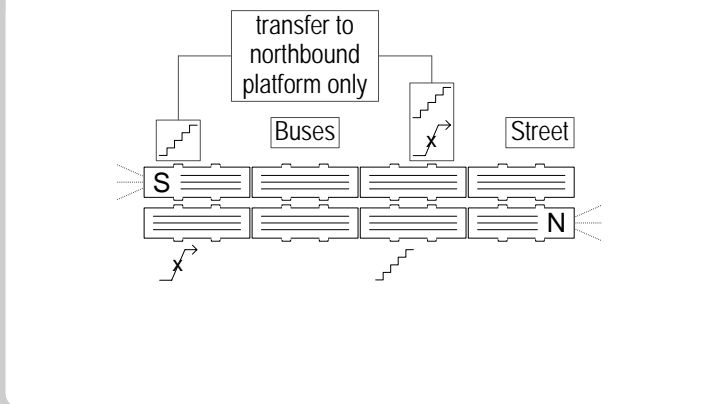

} page 39

Lawrence West

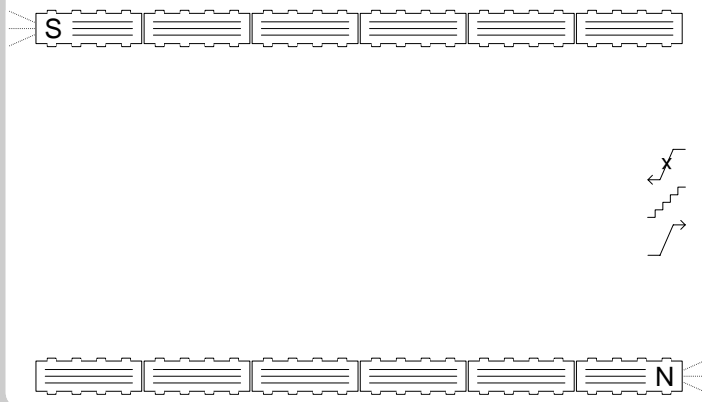

} page 40

Leslie

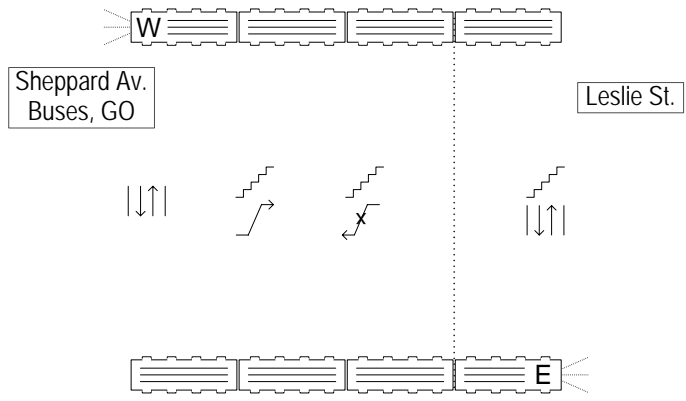

} page 41

Main Street

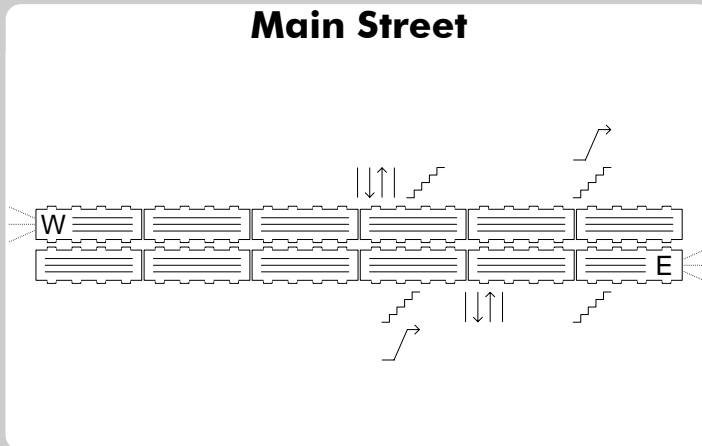

} page 42

McCowan

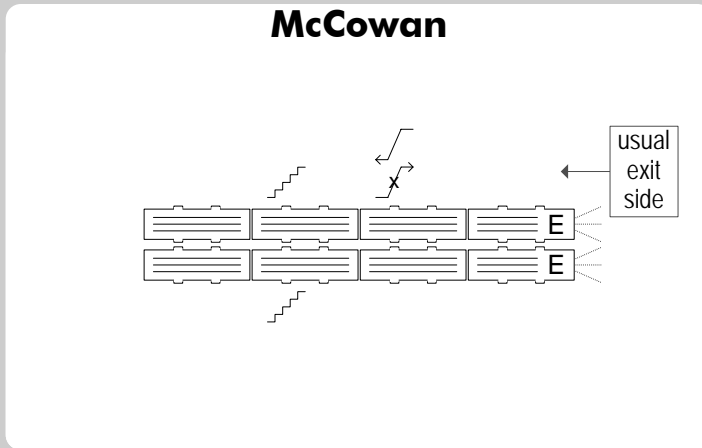

} page 43

Midland

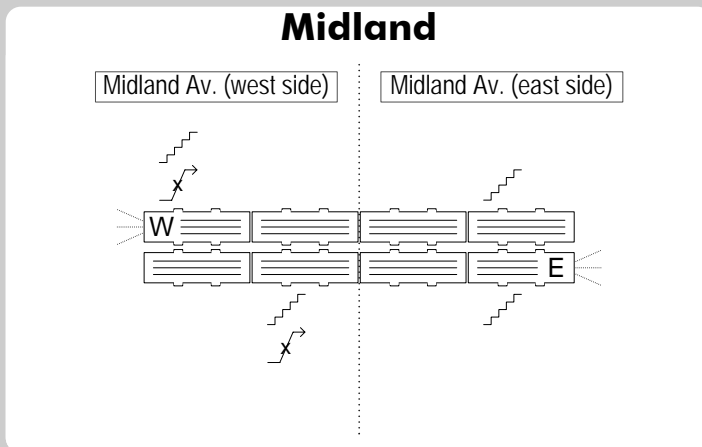

} page 44

Museum

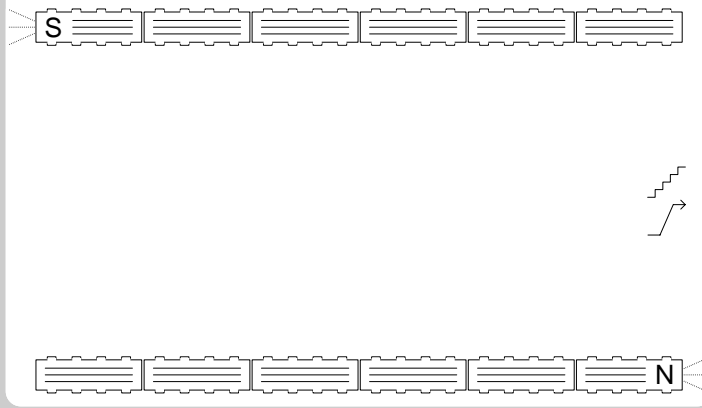

} page 45

Old Mill

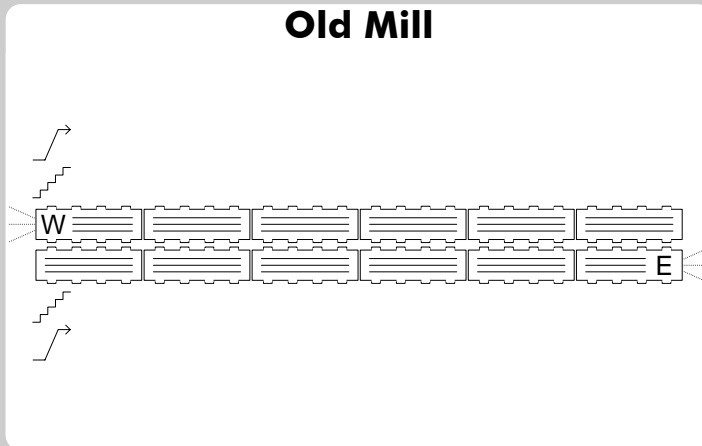

} page 46

North York Centre

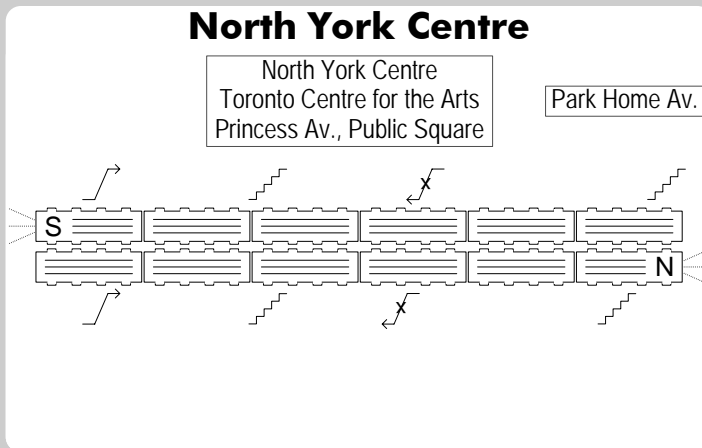

} page 47

Osgoode

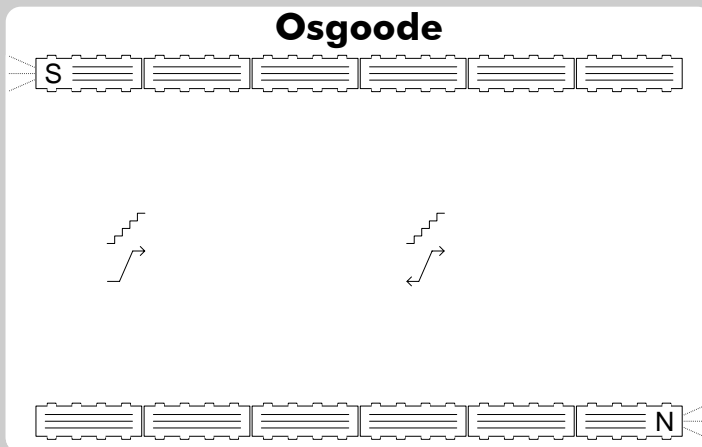

} page 48

Ossington

Delaware Av.

Ossington Av.
Buses

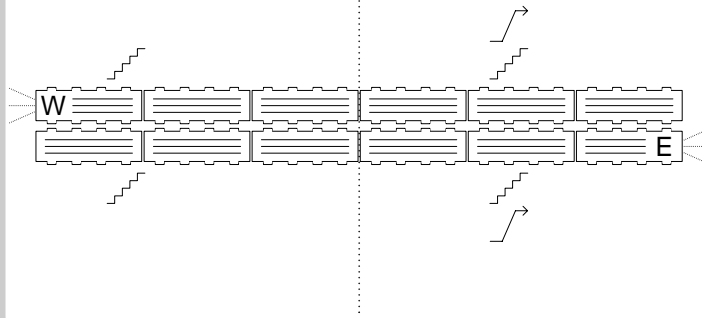

} page 49

Pape

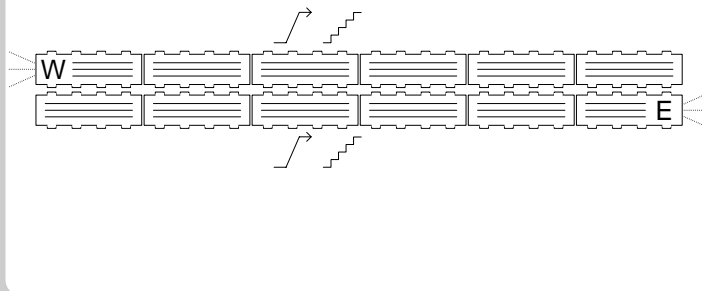

} page 50

Queen

Queen St.

Eaton Centre
City Hall

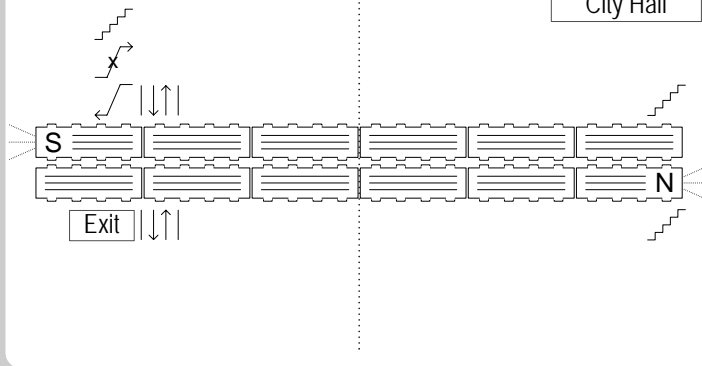

} page 51

Queen's Park

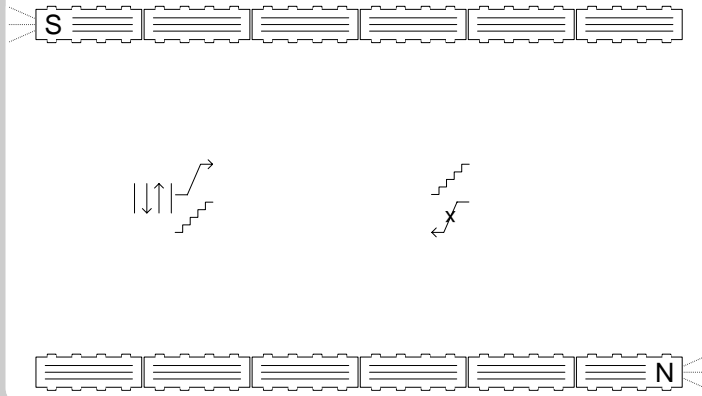

} page 52

Rosedale

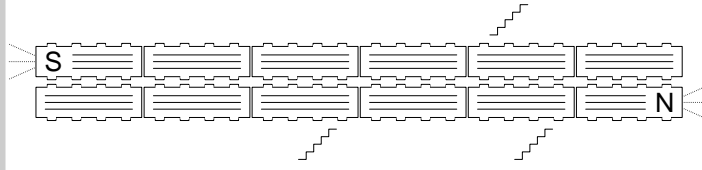

} page 53

Royal York

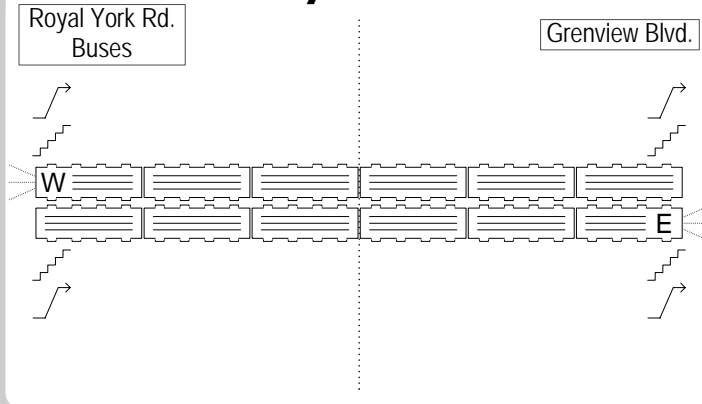

} page 54

Runnymede

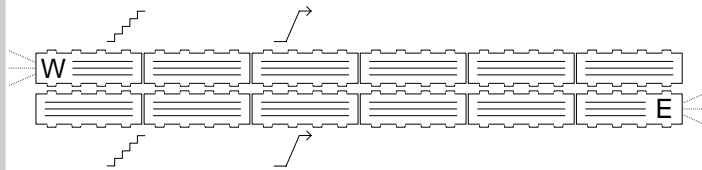

} page 55

Scarborough Centre

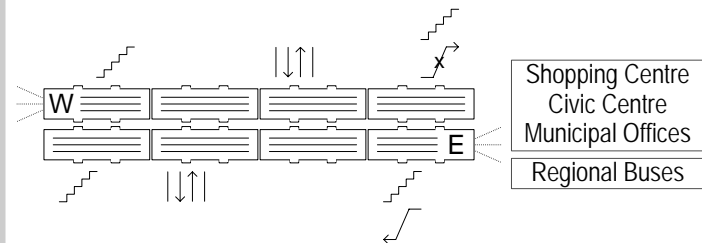

} page 56

Sheppard-Yonge (Sheppard Line)

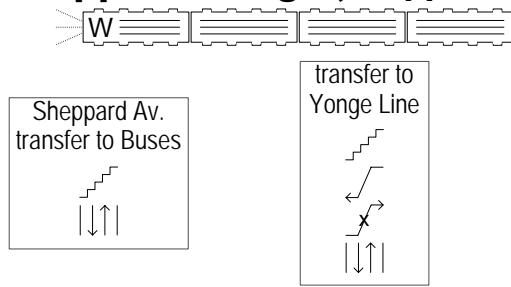

} page 57

Sheppard-Yonge (Yonge Line)

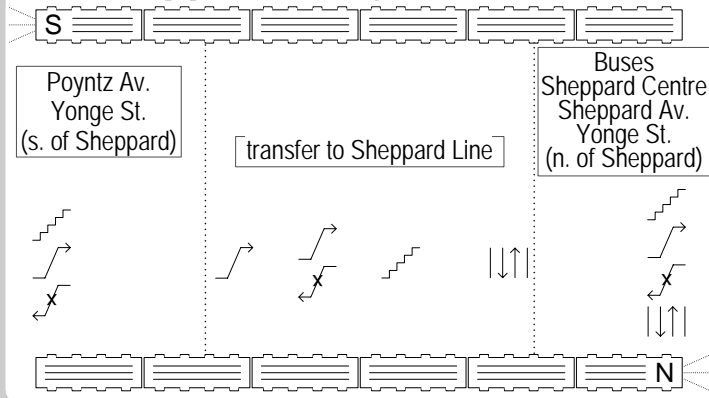

} page 58

Sherbourne

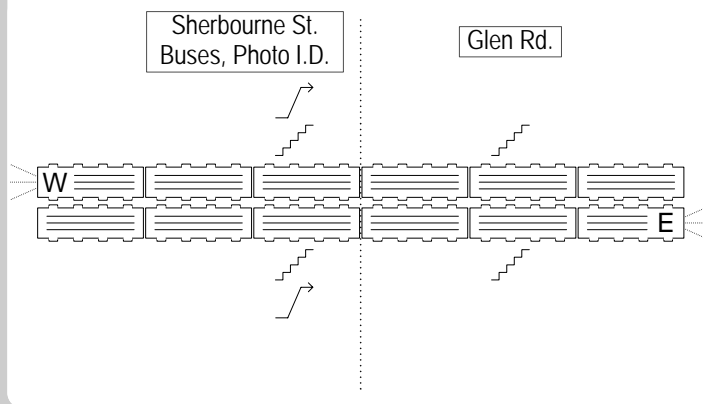

} page 59

Spadina (Bloor Line)

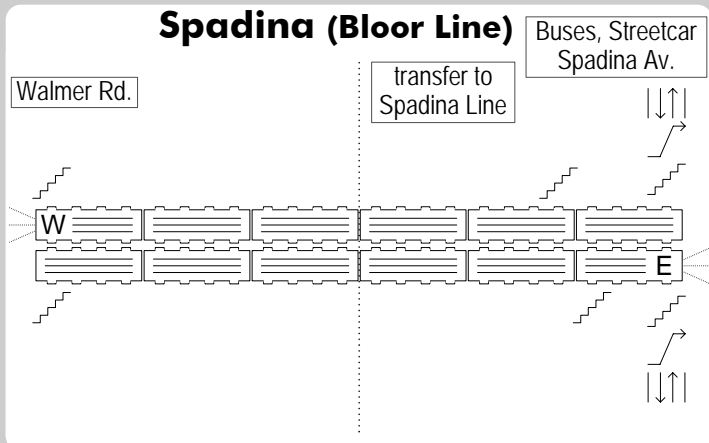

} page 60

Spadina (Spadina Line)

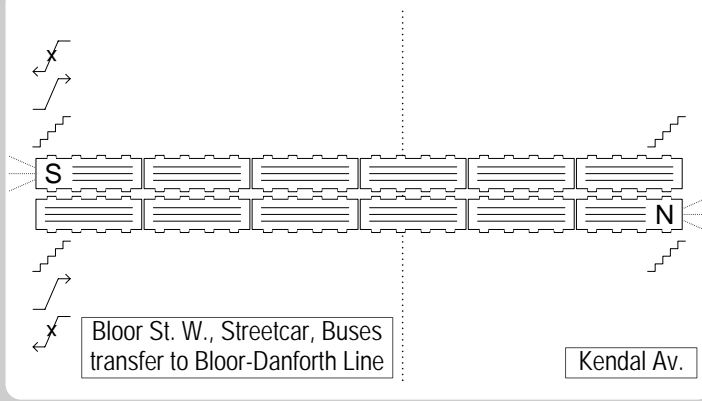

} page 61

St. Andrew

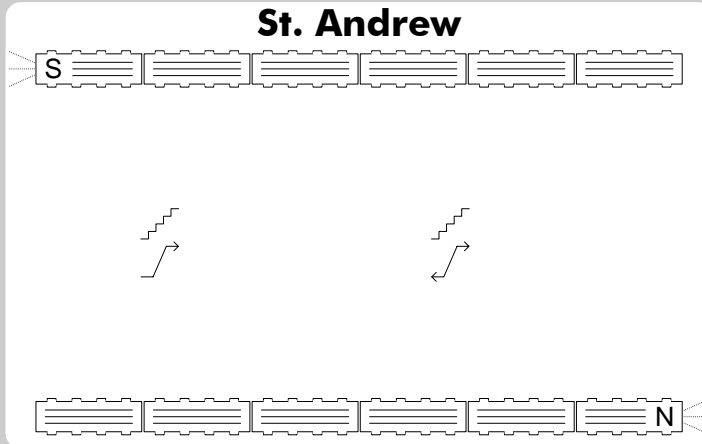

} page 62

St. Clair

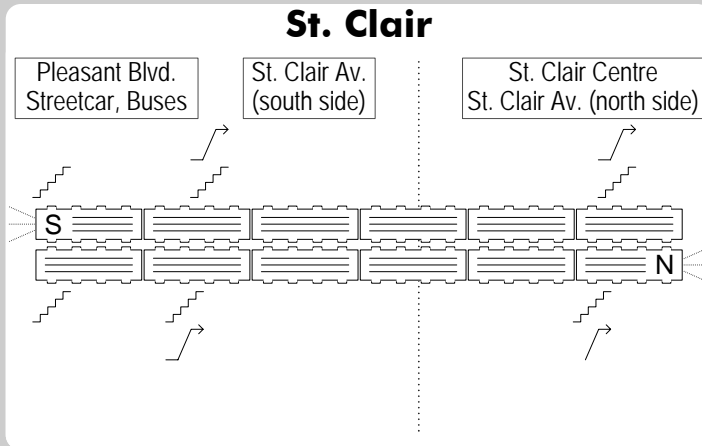

} page 63

St. Clair West

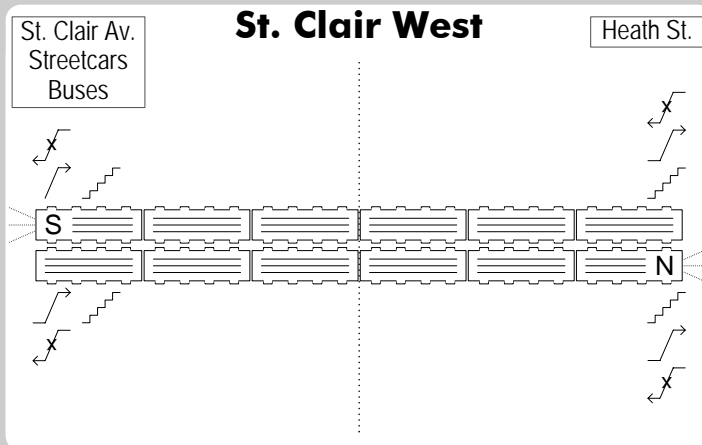

} page 64

St. George (Bloor Line)

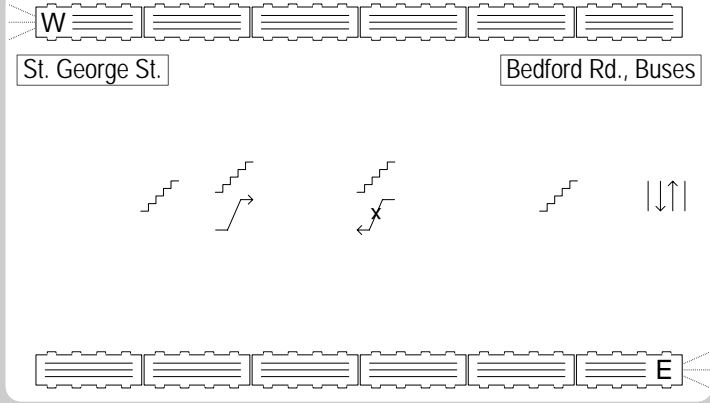

} page 65

St. George (Spadina Line)

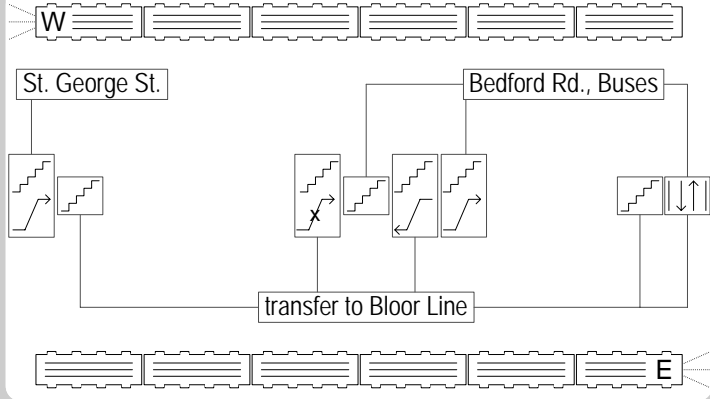

} page 66

St. Patrick

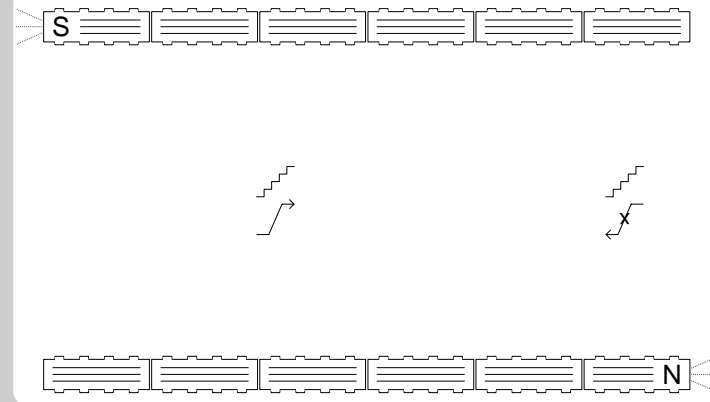

} page 67

Summerhill

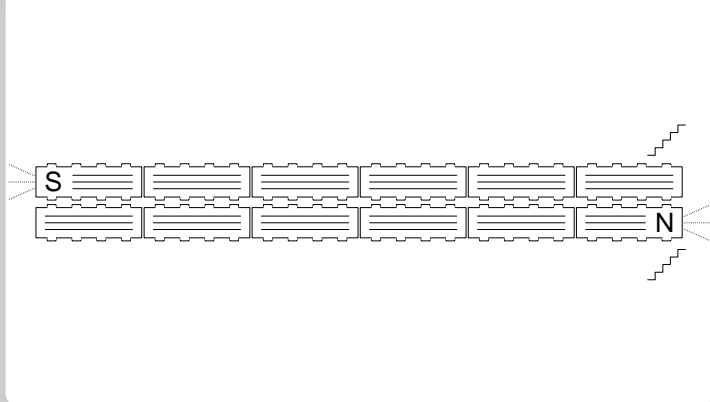

} page 68

Union

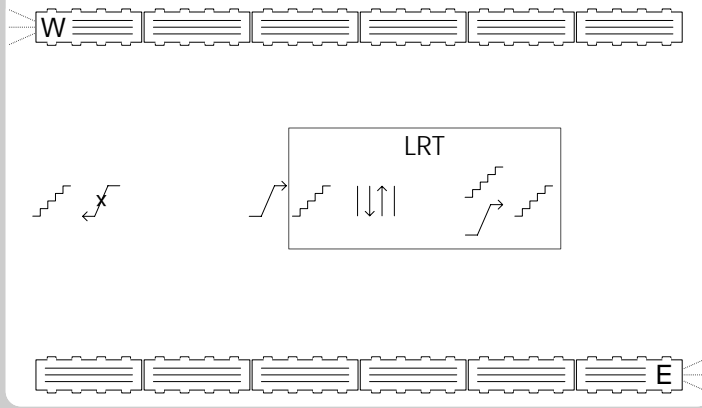

} page 69

Victoria Park

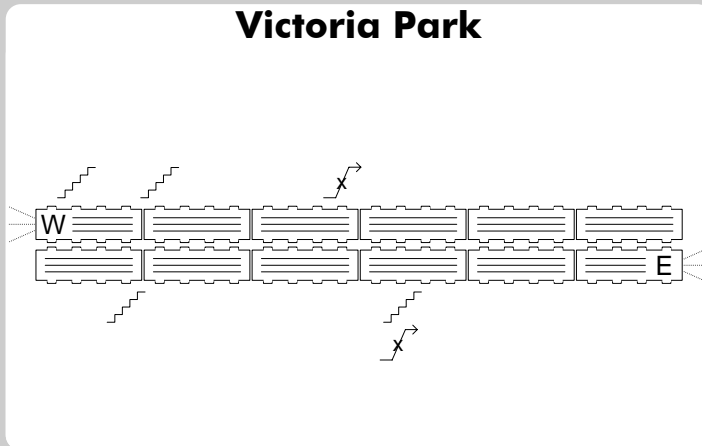

} page 70

Warden

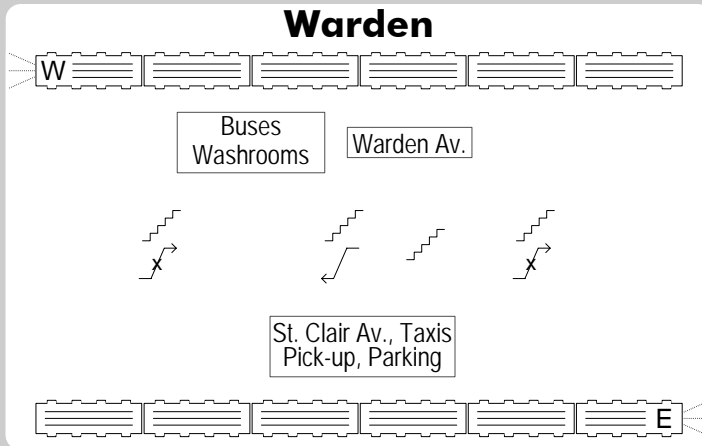

} page 71

Wellesley

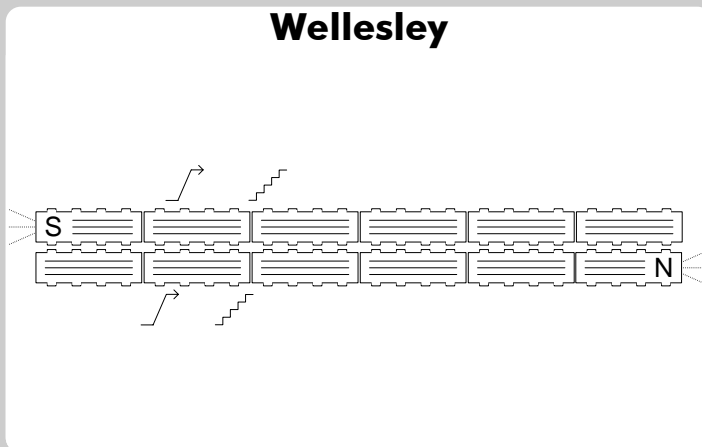

} page 72

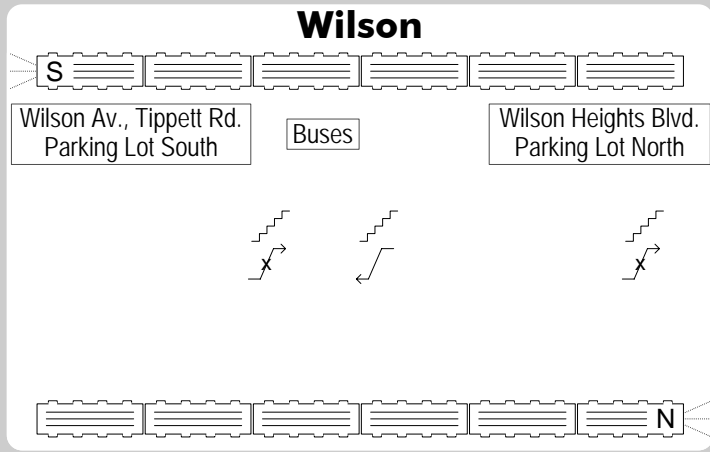

} page 73

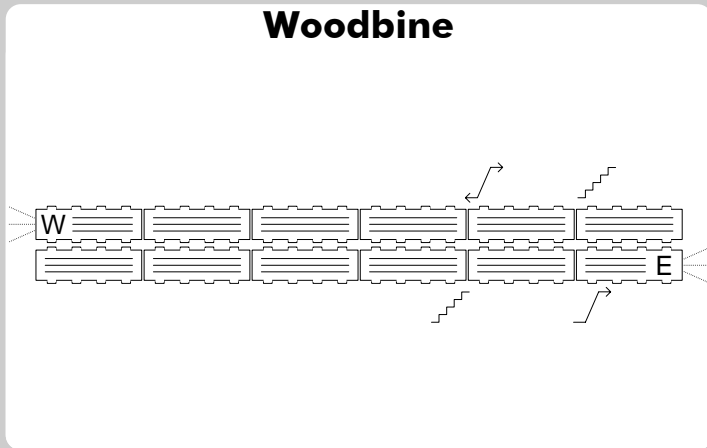

} page 74

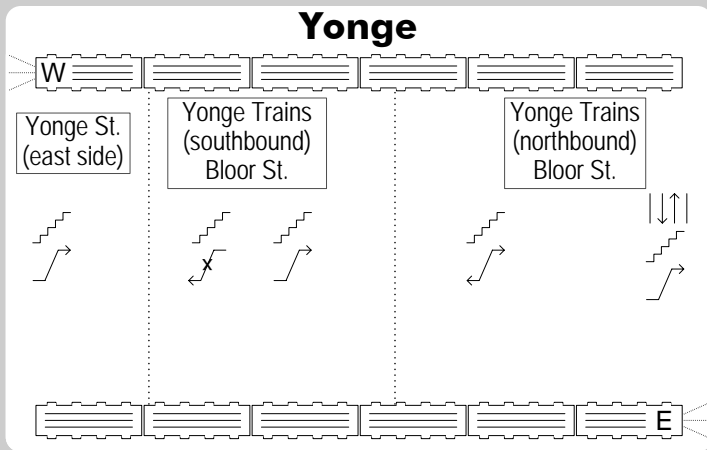

} page 75

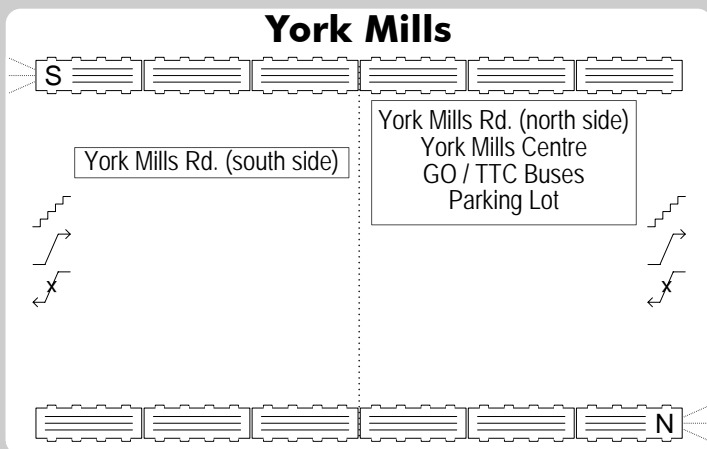

} page 76

Yorkdale



} page 77

tip: in most stations, the DWA (designated waiting area) lines up near the first door of the fifth car

} page 78

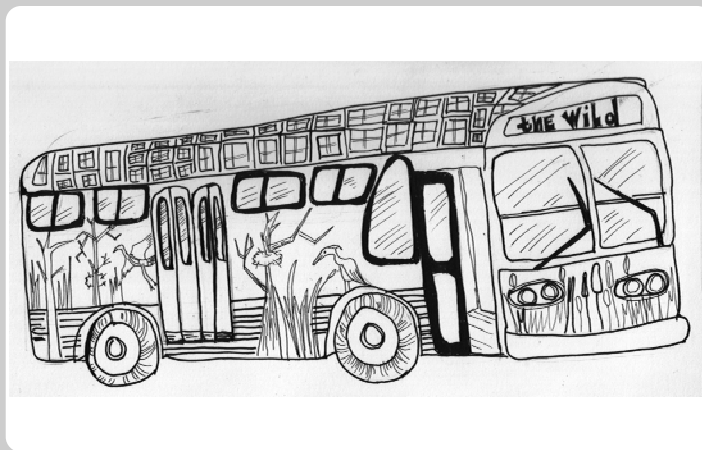

} page 79

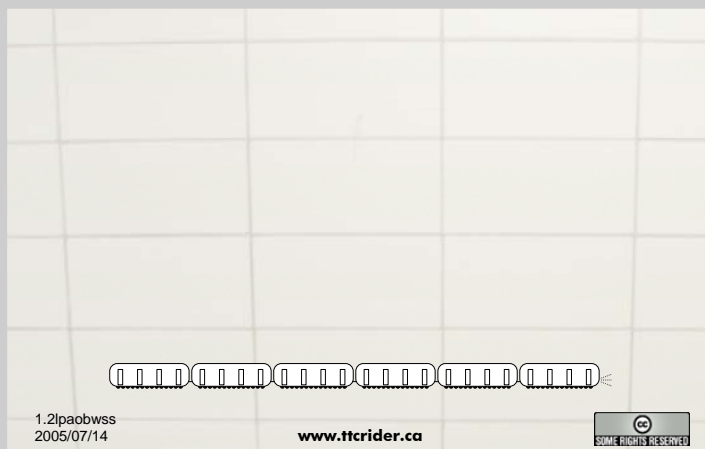

} bottom page

- put this page upside down so that it appears as the back of the guide